

JUNE – AUGUST 2018

Map & Guide



Incense burner
from 1800s
Japan in
*Reflections
of Asia.*

Welcome

Welcome to the Powerhouse Museum, where you will see an extraordinary array of treasures across decorative arts and design, science, technology, space and transport. We have a variety of exhibitions, programs, events and permanent displays.

Visit maas.museum and explore our collection online or find out more about our other venues, Sydney Observatory in the historic Rocks area and the Museums Discovery Centre at Castle Hill.

MAAS acknowledges Australia's First Nations Peoples as the Traditional Owners and Custodians of the land and gives respect to the Elders — past and present — and through them to all Aboriginal and Torres Strait Islander peoples.

Comments?

Your comments help us to improve our services. Ask for a comments form at the admission counter.

Contact

Telephone: (02) 9217 0111
Members: (02) 9217 0600
Bookings: (02) 9217 0222

Opening hours

10.00 am – 5.00 pm daily
(closed Christmas Day)

Address

500 Harris Street
Ultimo NSW 2007

Information correct at time of printing, May 2018, but may be subject to change. Go to maas.museum/phm for updates.



powerhousemuseum



@maasmuseum



@maasmuseum

MA
Museum of
Applied Arts
& Sciences

AS

NSW
GOVERNMENT

Cover image: from *Reigning Men*,
Johnson Hartig for Libertine, 2009–10.
LACMA Collection. Photo © LACMA.

Museum highlights

Level 4

Fantastical Worlds

From 7 August

Admire the creative brilliance behind historical baroque and rococo designs and the contemporary works inspired by them.



Lucky Iron Fish in *Common Good*.
Photo © Lucky Iron Fish



María Fernanda Cardoso's *The Marriages of Plants* (detail), 2018, in *Human non Human*. Courtesy of the artist

Level 3

Icons

See little-known treasures from the MAAS collection and rediscover old favourites in an exhibition reinterpreting the conventional notion of an 'icon'.

Download the free audio tour maas.museum/apps. 

40 Years of Fabulousness: Sydney Gay and Lesbian Mardi Gras

See costumes and posters from this colourful and lively spectacle, which has grown over 40 years from a small political march to the world's biggest gay and lesbian festival, attracting crowds of over half a million.

Tours and talks

Daily exhibition tours, talks and demonstrations. Details at the information desk and on the app.



Tim Ross with the Café-Bar from *Design Nation*.

Level 2

Reigning Men: Fashion in Menswear, 1715–2015

Over 130 ensembles drawn primarily from the Los Angeles County Museum of Art collection, as well as a display of Australian men's style from the MAAS collection.

Common Good

Explore the impact of contemporary design practice in Australia and neighbouring regions, with designers leading us towards a sustainable future.

Four Periscopes: 2018 MAAS Architectural Commission

Commissioned by MAAS, this work by architectural studio TRIAS encourages visitors to connect with one another through a matrix of mirrors contained in four towers.

Student Fashion 2018

This annual display highlights the creativity and inspiration behind the designs of the top graduates from Sydney fashion schools.

Interface: People, Machines, Design

Interface presents some of the great consumer products of the 20th and 21st centuries.

Kings Cinema

Daily screenings. Details at the information desk.

Level 1

Design Nation

Curated by Tim Ross, this exhibition brings together examples of ingenuity from the MAAS collection.

A Brilliant Gift: The Barry Willoughby Bequest

This selection of glass objects is part of a generous bequest from Museum patron Barry Willoughby.

Reflections of Asia: Collectors and Collections

From 7 July

For the first time ever, MAAS showcases its extensive Asian collection developed over the past 140 years.

Spinning World

From 7 July

A multimedia installation comprising textiles and electronics inspired by a Japanese kimono.

Human non Human

From 8 August

Art, science and speculation converge in these four immersive installations.

Experimentations

Become the scientist, engineer, thinker, artist and inventor in this dynamic exhibition.

EcoLogic

Discover the science behind climate change and global warming.



Checking out the sights in *The Wiggles Exhibition*.

For families

Our most popular exhibitions with families include **Space**, **Transport** and **The Wiggles Exhibition** on level 1.

Special activities

Level 1 MAAS Minis & Tinies

Curious creators under five can explore the Museum in these hands-on sessions. Monthly, book online at maas.museum

Sydney Science Festival Family Day

Interactive science shows, hands-on experiences and demonstrations for all the family. 12 August, 10.00 am–4.00 pm

Kid Couture

Become a designer in our fashion and textile making zone. Create your own wearable piece, weave a textile or book in for a digital workshop. From 7 to 22 July, 10.00 am–5.00 pm.

Regular activities

Level 1

Be inspired to reflect on your own treasured objects by the story of David Hain and his little radio in the **Red Room Poetry Object 2018** display.

Explore the **Experimentations** exhibition where young visitors can become the scientist, engineer, thinker, artist and inventor.

There is also a courtyard **Playground**, baby change facilities and a toddlers toilet on level 1.

Level 2

Visit **The Lab**, an imaginative play space that responds to your interactions.

Free general admission for kids

Activities may change. Ask at the information desk.

Facilities

Cafés

Levels 1 and 3

Our cafés are open from breakfast, serving quality coffee as well as a delicious family-friendly menu.

Dine indoors or out at MAAS Junction on level 1, which connects to The Goods Line, or MAAS Café on level 3 with access to Harris Street.



Grab a coffee or have lunch at the MAAS Junction café on level 1.

MAAS Store

Level 3

Exit via the MAAS Store to purchase a wide range of books, gifts and homewares. Profits go towards the purchase or conservation of objects.

Members Lounge

Level 3 (entry via level 1)

Complimentary refreshments and a children's play area are available for members.

Photography

We welcome personal and non-commercial photography but please don't use flash as light can damage objects.

Toilets

Toilets and baby change facilities are located on all levels.

Free wi-fi

Free wi-fi is available throughout the Museum and its cafés. Sign in as MAAS visitor.

Free app

Download our free app to make the most of your visit. The app includes details of current exhibitions, workshops, talks and special events, and a self-guided audio tour of the *Icons* exhibition.



The Lab

Level 2

The Lab is a hands-on play space dedicated to interactive technologies, open to the public. It is also a venue for special events and workshops featuring computer science, digital media, game design and making where you can learn a skill, tinker with tools, make a project and share ideas; bookings essential. For more details visit maas.museum/thelab.

Lace Study Centre

Level 2 (Studio 1, The Lab)

See exquisite lace from around the world.

Additional requirements

For strollers and wheelchairs, and information about services for visitors with accessibility needs, ask at the cloaking desk.

Discount parking

Darling Square Car Park, Haymarket (\$12 Monday–Friday, \$8 weekends).
Novotel Sydney Central, Haymarket (\$15).

Parking tickets must be validated by the machine located in the MAAS Store or level 1 entrance.

Level 4

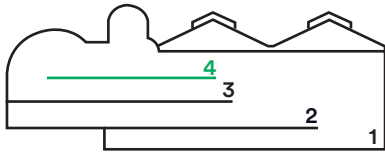

- Facilities**
 Toilets
 Parents room

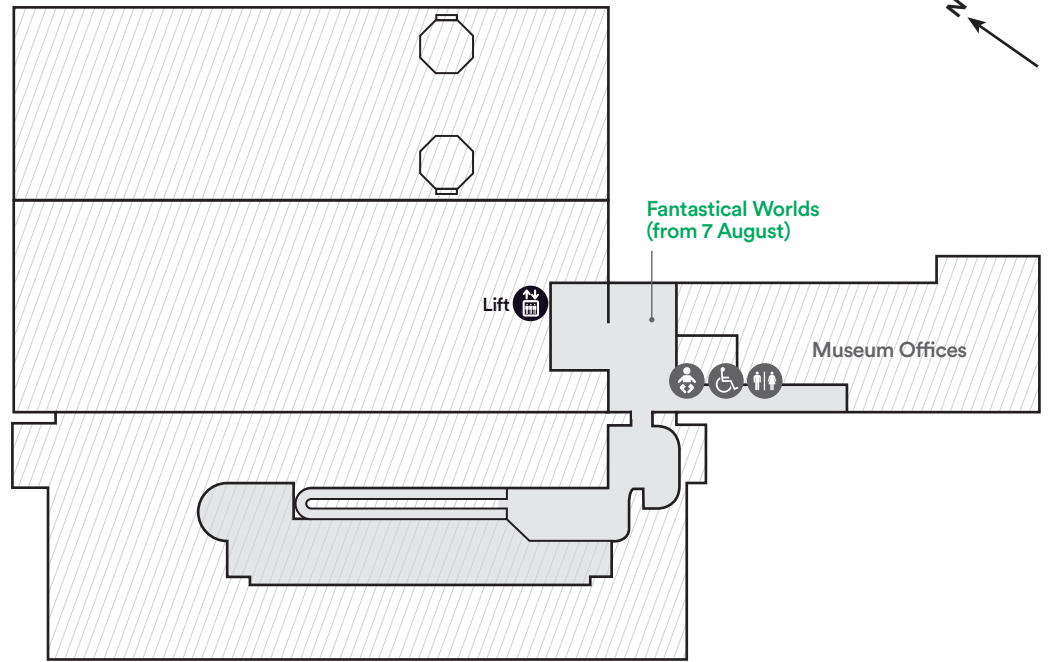

Level 3 ENTRY & EXIT

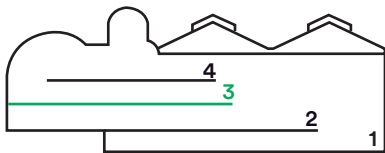

- Facilities**
 Toilets
 Admission
 Cloaking desk
 Members Lounge
 Information
 Shop
 Café
 Lost property

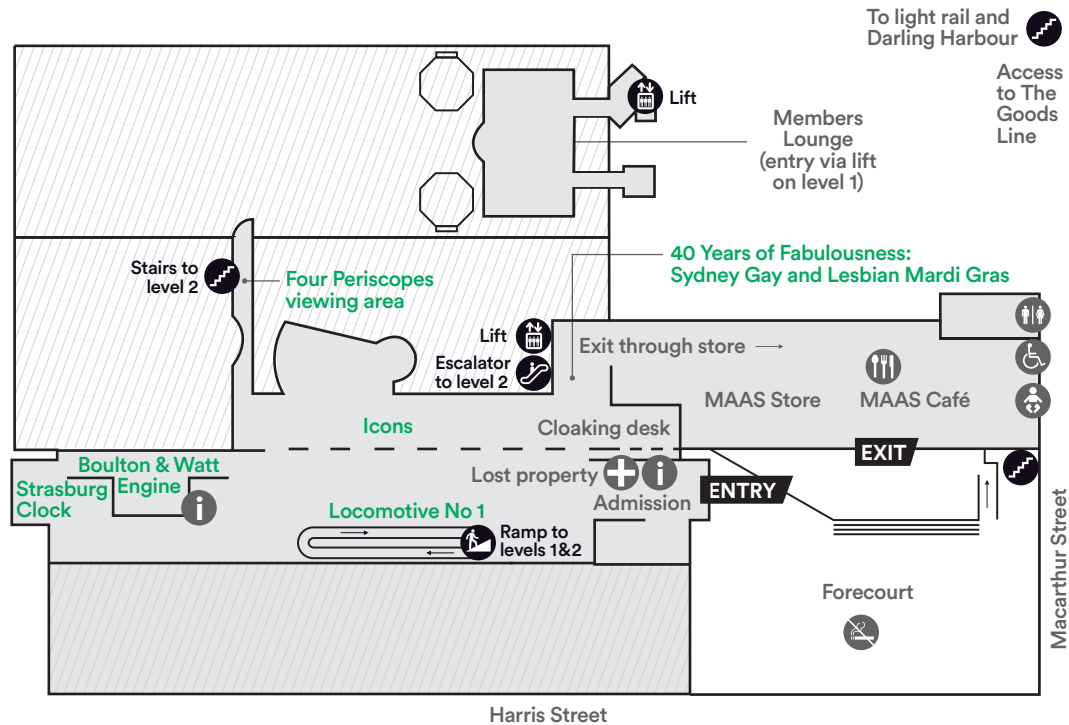

Level 2

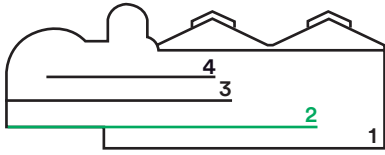

- Facilities**
 Toilets
 Parents room
 Theatres

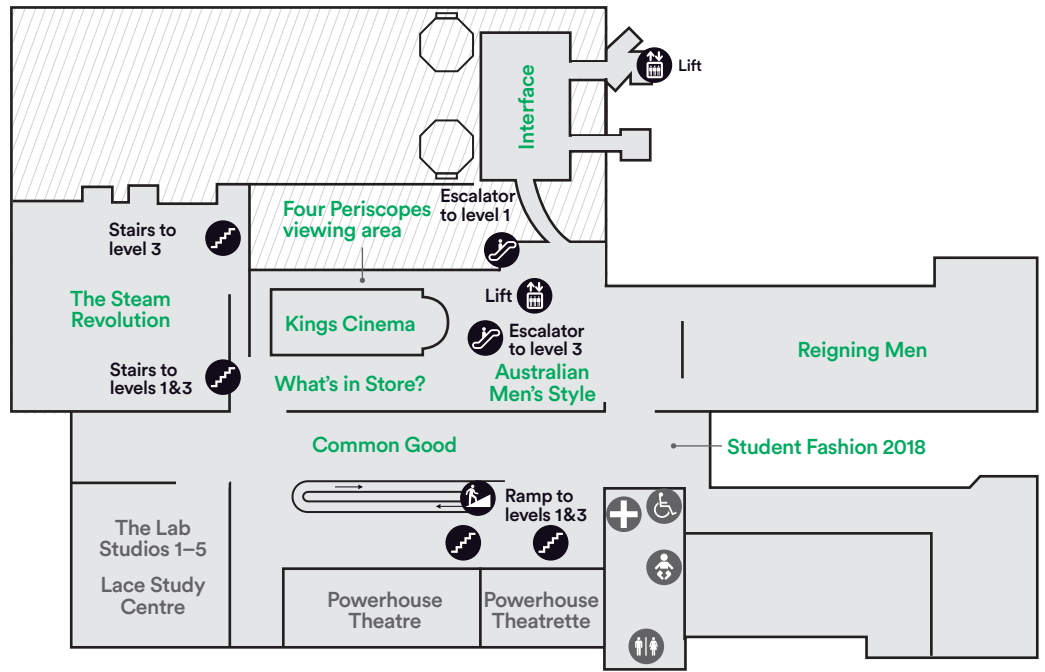

Level 1 ENTRY & EXIT

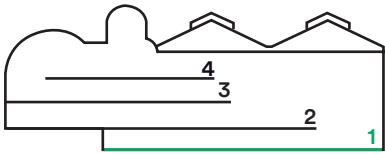

- Facilities**
 Toilets
 Pram parking
 Café
 Playground
 Courtyard
 Lost property

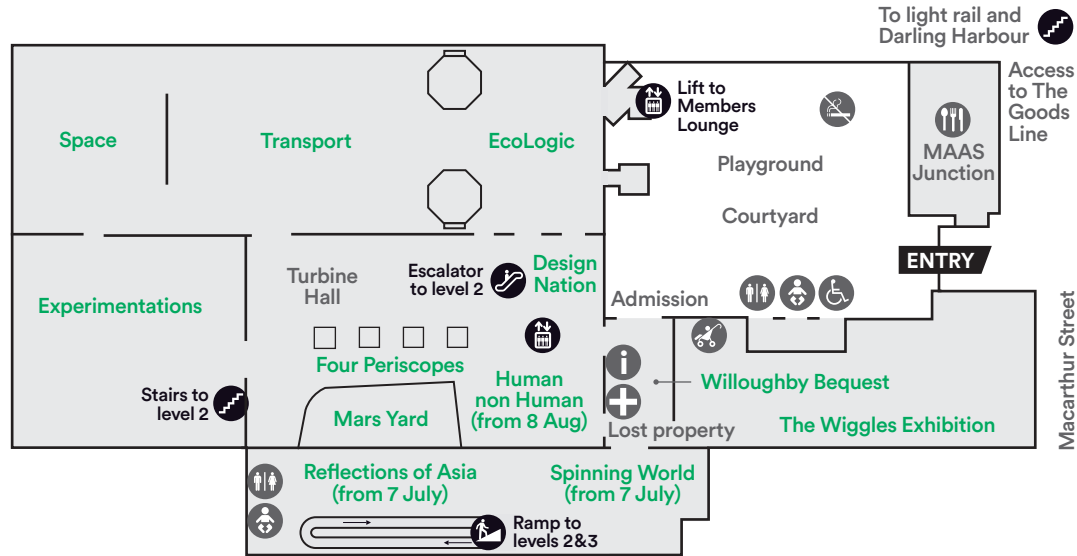

- Ramp
- Stairs
- Information
- Accessible toilets
- Baby change & toddler toilet
- Café
- Lift
- Escalators
- First aid
- Toilets
- Pram parking
- The Museum is a smoke-free zone